

Features

- Hybrid 6-pin package
- 1500Vdc isolation voltage
- Photodarlington Output
- Small package outline
- High reliability and rugged construction
- High reliability screening available
- Radiation tolerant
- Open collector output
- Operating temperature range -55°C to +125°C

Applications

- Switch mode power supplies
- Computer peripheral interface
- Motor control
- Ground signal isolation

Description

The IBI400 consists of a phototransistor optically coupled to an AlGaAs infrared-emitting diode in a leadless hybrid surface mount package.

Schematic Diagram

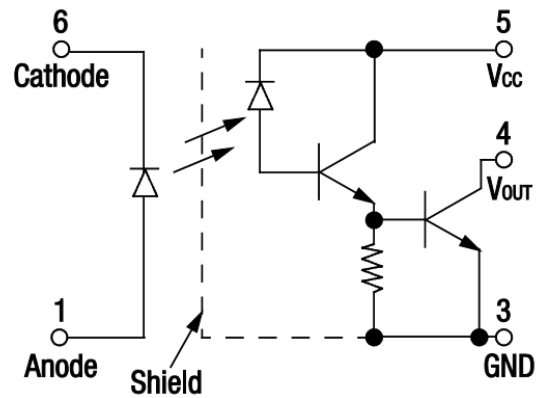

Figure 1. IBI400 Schematic Diagram

Package Dimensions in inches (mm)

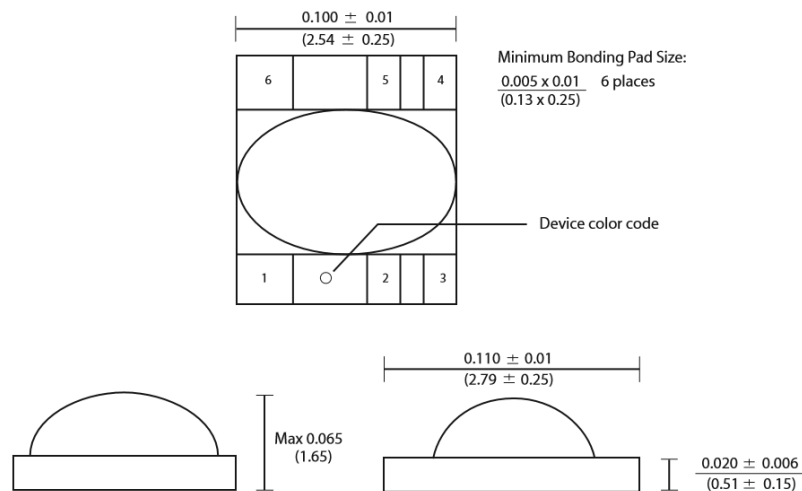

Figure 2. IBI400 Package Dimensions

Absolute Maximum Rating at 25°C (Note 1)

Symbol	Parameters	Ratings	Units	Notes
V _{DC}	Isolation voltage	-1500 to +1500	V	2
T _{OPR}	Operating temperature	-55 to +125	°C	
T _{STG}	Storage temperature	-65 to +150	°C	
T _{SOL}	Soldering temperature (10 seconds maximum)	240	°C	
Emitter				
P _D	Emitter power dissipation	36	mW	
I _F	Forward current	20	mA	
I _{F(TRANS)}	Peak transient current (≤1ms P.W.)	40	mA	
V _R	Reverse voltage	5	V	
Detector				
P _D	Detector power dissipation	50	mW	3
I _O	Output Current	8	mA	
I _{O(PEAK)}	Peak Output Current	16	mA	
V _{CC}	Supply Voltage	-0.5 to +20	V	
V _O	Output Voltage	-0.5 to +20	V	

Notes

1. When using this product, please observe the absolute maximum ratings. Only one parameter may be set at the limit to ensure no damage to the device. Exceeding any of the limits listed here may damage the device.
2. Measured between input pins 1 and 6 shorted together, and output pins 2, 3, 4, and 5 shorted together. T_A = 25°C and duration = 1sec.
3. Linear derating factor: 1.4 mW/°C above 100°C

ESD Precaution

Please be advised that normal static precautions should be taken in the handling and assembly of this device to prevent damage or degradation which may be induced by electrostatic discharge (ESD).

Electrical Characteristics $T_A = -55^{\circ}\text{C}$ to $+125^{\circ}\text{C}$ (unless otherwise specified) (Note 1)

Emitter Characteristics

Symbol	Parameters	Test Conditions	Min	Typ	Max	Units	Notes
V_F	Forward Voltage	$I_F=1.6\text{mA}$	-	1.65	2.0	V	
B_{VR}	Input Breakdown Reverse Voltage	$I_R=10\mu\text{A}$	3	-	-	V	

Detector Characteristics

Symbol	Parameters	Test Conditions	Min	Typ	Max	Units	Notes
V_{OL}	Logic Low Output Voltage	$I_F=0.5\text{mA}, I_{OL}=1.5\text{mA}, V_{CC}=4.5\text{V}$	-	0.1	0.4	V	
		$I_F=5\text{mA}, I_{OL}=10\text{mA}, V_{CC}=4.5\text{V}$	-	0.2	0.4	V	
I_{OH}	Logic High Output Current	$I_F=0\text{mA}, V_{CC}=18\text{V}, V_O=18\text{V}$	-	0.005	250.0	μA	
I_{CCL}	Logic Low Supply Current	$I_F=1.6\text{mA}, V_{CC}=18\text{V}, V_O=\text{open}$	-	0.6	2	mA	
I_{CCH}	Logic High Supply Current	$I_F=0\text{mA}, V_{CC}=18\text{V}, V_O=\text{open}$	-	0.01	40	μA	

Transfer Characteristics

Symbol	Parameters	Test Conditions	Min	Typ	Max	Units	Notes
CTR	Current Transfer Ratio	$I_F=0.5\text{mA}, V_{CC}=4.5\text{V}, V_O=0.4\text{V}$	300	-	-	%	2
		$I_F=1.6\text{mA}, V_{CC}=4.5\text{V}, V_O=0.4\text{V}$	300	-	-	%	2
		$I_F=5\text{mA}, V_{CC}=4.5\text{V}, V_O=0.4\text{V}$	200	-	-	%	2
CM_H	Common Mode Transient Immunity High Output Level	$I_F=0\text{mA}, V_{CC}=5\text{V}, T_A=25^{\circ}\text{C}$	500	2,000	-	V/ μs	3
CM_L	Common Mode Transient Immunity Low Output Level	$I_F=1.6\text{mA}, V_{CM}=50\text{Vpeak}, V_{CC}=5\text{V}, R_L=1.5\text{k}\Omega, T_A=25^{\circ}\text{C}$	500	2,000	-	V/ μs	3
I_{IO}	Input to Output Leakage Current	$V_{IO}=1500\text{VDC}, T_A=25^{\circ}\text{C},$ Relative Humidity $\leq 50\%$	-	-	1	μA	4

Propagation Delay Time

Symbol	Parameters	Test Conditions	Min	Typ	Max	Units	Notes
t_{PHL}	Logic High to Low	$I_F=0.5\text{mA}, V_{CC}=5\text{V},$ $R_L=4.7\text{k}\Omega, T_A=25^{\circ}\text{C}$	-	26	100	μs	3
t_{PLH}	Logic Low to High		-	2	10		3
t_{PHL}	Logic High to Low	$I_F=5\text{mA}, V_{CC}=5\text{V},$ $R_L=680\Omega, T_A=25^{\circ}\text{C}$	-	28	60	μs	3
t_{PLH}	Logic Low to High		-	10	30		3

Notes

- Performance guaranteed only under conditions listed in above tables.
- CTR is the ratio of the output collector current I_{C_ON} to the forward LED current I_F multiplied by 100%
- A ceramic bypass capacitor (0.01 μF to 0.1 μF) between pins 3 and 5 is required to stabilize the operation of the amplifier
- Measured between input pins 1 and 6 shorted together, and output pins 2, 3, 4, and 5 shorted together. $T_A = 25^{\circ}\text{C}$ and duration = 1sec.

Typical Characteristic Curves

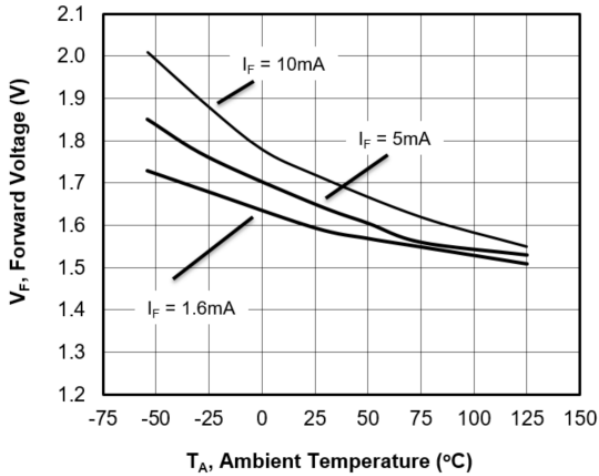
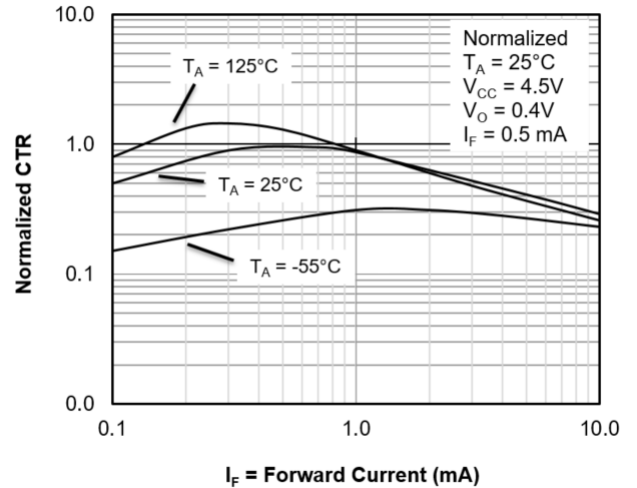
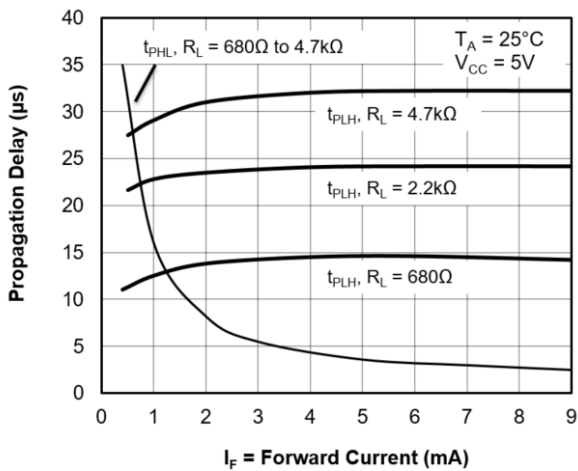
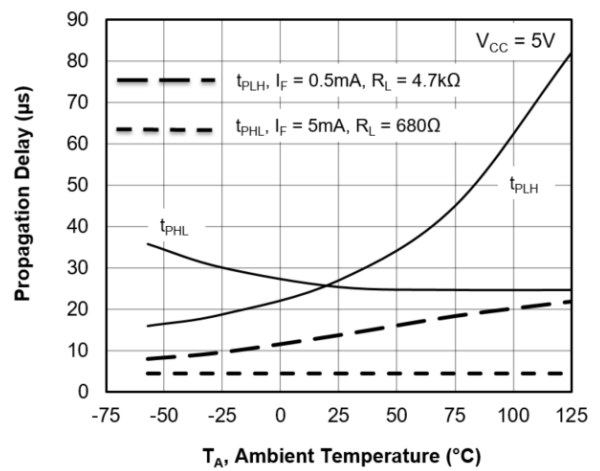
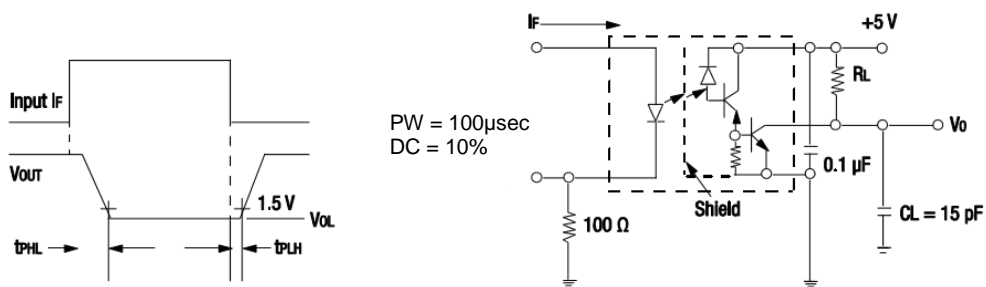
Figure 3. Forward Voltage vs Temperature

Figure 4. Output Current vs Temperature

Figure 5. Propagation Delay vs Forward Current

Figure 6. Propagation Delay vs Temperature

Figure 6. IBI400 Switching Test Circuit



Ordering Information

<i>Manufacturing Part Number</i>	<i>Part Description</i>
IBI400	Radiation Tolerant PhotoDarlington 6-pin Hybrid Package

DISCLAIMER

Isobaud Inc. reserves the right to make changes without further notice to any products herein to improve reliability, function or design. Isobaud Inc. does not assume any liability arising out of the application or use of any product or circuit described herein; neither does it convey any license under its patent rights, nor the rights of others.